

# KATANA<sup>®</sup>

## CORDLESS IMPACT DRIVER INSTRUCTION MANUAL

*18V CHARGE-ALL*

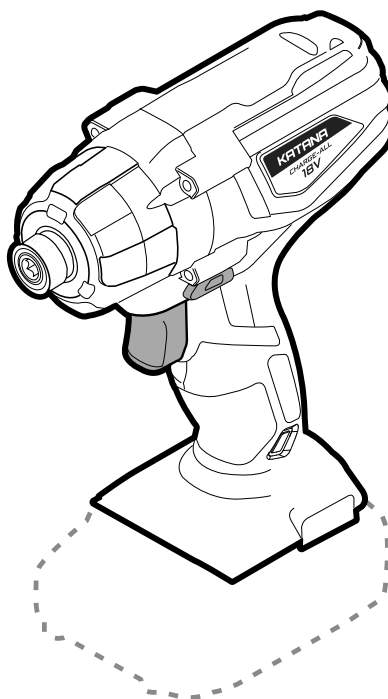

**18V**  
LITHIUM ION

**5 YEAR**  
WARRANTY\*

**158N<sub>m</sub>**  
MAX TORQUE

220010

## GENERAL POWER TOOL SAFETY WARNINGS

220010



**WARNING** Read all safety warnings and all instructions. Failure to follow the warnings and instructions may result in electric shock, fire and/or serious injury. Save all warnings and instructions for future reference. The term "power tool" in the warnings refers to your mains-operated (corded) power tool or battery-operated (cordless) power tool.

## 1) Work area safety

- a) **Keep work area clean and well lit.** Cluttered or dark areas invite accidents.
- b) **Do not operate power tools in explosive atmospheres, such as in the presence of flammable liquids, gases or dust.** Power tools create sparks which may ignite the dust or fumes.
- c) **Keep children and bystanders away while operating a power tool.** Distractions can cause you to lose control.

## 2) Electrical safety

- a) **Power tool plugs must match the outlet. Never modify the plug in any way. Do not use any adapter plugs with earthed (grounded) power tools.** Unmodified plugs and matching outlets will reduce risk of electric shock.
- b) **Avoid body contact with earthed or grounded surfaces, such as pipes, radiators, ranges and refrigerators.** There is an increased risk of electric shock if your body is earthed or grounded.
- c) **Do not expose power tools to rain or wet conditions.** Water entering a power tool will increase the risk of electric shock.
- d) **Do not abuse the cord. Never use the cord for carrying, pulling or unplugging the power tool. Keep cord away from heat, oil, sharp edges or moving parts.** Damaged or entangled cords increase the risk of electric shock.
- e) **When operating a power tool outdoors, use an extension cord suitable for outdoor use.** Use of a cord suitable for outdoor use reduces the risk of electric shock.
- f) **If operating a power tool in a damp location is unavoidable, use a residual current device (RCD) protected supply.** Use of an RCD reduces the risk of electric shock.

## 3) Personal safety

- a) **Stay alert, watch what you are doing and use common sense when operating a power tool. Do not use a power tool while you are tired or under the influence of drugs, alcohol or medication.** A moment of inattention while operating power tools may result in serious personal injury.
- b) **Use personal protective equipment. Always wear eye protection.** Protective equipment such as dust mask, non-skid safety shoes, hard hat, or hearing protection used for appropriate conditions will reduce personal injuries.
- c) **Prevent unintentional starting. Ensure the switch is in the off-position before connecting to power source and/or battery pack, picking up or carrying the tool. Carrying power tools with your finger on the**

*switch or energising power tools that have the switch on invites accidents.*

- d) **Remove any adjusting key or wrench before turning the power tool on.** A wrench or a key left attached to a rotating part of the power tool may result in personal injury.
- e) **Do not overreach. Keep proper footing and balance at all times.** This enables better control of the power tool in unexpected situations.
- f) **Dress properly. Do not wear loose clothing or jewellery. Keep your hair, clothing and gloves away from moving parts.** Loose clothes, jewellery or long hair can be caught in moving parts.
- g) **If devices are provided for the connection of dust extraction and collection facilities, ensure these are connected and properly used.** Use of dust collection can reduce dust-related hazards.

## 4) Power tool use and care

- a) **Do not force the power tool. Use the correct power tool for your application.** The correct power tool will do the job better and safer at the rate for which it was designed.
- b) **Do not use the power tool if the switch does not turn it on and off.** Any power tool that cannot be controlled with the switch is dangerous and must be repaired.
- c) **Disconnect the plug from the power source and/or the battery pack from the power tool before making any adjustments, changing accessories, or storing power tools.** Such preventive safety measures reduce the risk of starting the power tool accidentally.
- d) **Store idle power tools out of the reach of children and do not allow persons unfamiliar with the power tool or these instructions to operate the power tool.** Power tools are dangerous in the hands of untrained users.
- e) **Maintain power tools. Check for misalignment or binding of moving parts, breakage of parts and any other condition that may affect the power tool's operation. If damaged, have the power tool repaired before use.** Many accidents are caused by poorly maintained power tools.
- f) **Keep cutting tools sharp and clean.** Properly maintained cutting tools with sharp cutting edges are less likely to bind and are easier to control.
- g) **Use the power tool, accessories and tool bits etc. in accordance with these instructions, taking into account the working conditions and the work to be performed.** Use of the power tool for operations different from those intended could result in a hazardous situation.

## 5) Battery tool use and care

- a) **Recharge only with the charger specified by the manufacturer.** A charger that is suitable for one type of battery pack may create a risk of fire when used with another battery pack.
- b) **Use power tools only with specifically designated battery packs.** Use of any other battery packs may create a risk of injury and fire.

## TOOL ASSEMBLY

220010

- c) **When battery pack is not in use, keep it away from other metal objects, like paper clips, coins, keys, nails, screws or other small metal objects, that can make a connection from one terminal to another. Shorting the battery terminals together may cause burns or a fire.**
- d) **Under abusive conditions, liquid may be ejected from the battery; avoid contact. If contact accidentally occurs, flush with water. If liquid contacts eyes, additionally seek medical help. Liquid ejected from the battery may cause irritation or burns.**

### 6) Service

- a) **Have your power tool serviced by a qualified repair person using only identical replacement parts. This will ensure that the safety of the power tool is maintained.**

### Additional Safety Instructions impact driver

- 1) **Wear ear protectors when impact drilling. Exposure to noise can cause hearing loss.**
- 2) **Use auxiliary handle(s), if supplied with the tool. Loss of control can cause personal injury**
- 3) **Hold power tool by insulated gripping surfaces, when performing an operation the cutting accessory may contact hidden wiring or its own cord. Cutting accessory contacting a "live" wire may make exposed metal parts of the power tool "live" and could give the operator an electric shock.**

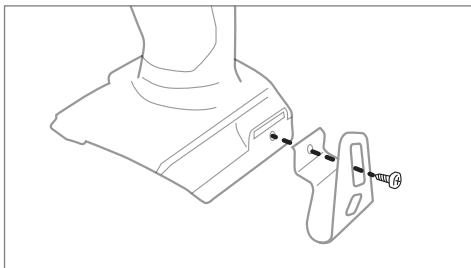

### INSTALLING THE BELT CLIP

Place provided belt clip (3) in the desired position on the base of the impact driver. Using a Phillips head #2 screwdriver, place screw through clip into screw hole & hand tighten until you feel resistance & clip is adequately tight.

## SYMBOLS

The rating plate on your tool may show symbols. These represent important information about the product or instructions on its use.

	Direct current, DC		Waste electrical products should not be disposed of with household waste. Please recycle where facilities exist. Check with your Local Authority or retailer for recycling advice.
	Refer to instruction manual/booklet		
	Wear ear protection		General warning
	Wear eye protection		Regulator compliance mark

## KNOW YOUR PRODUCT

220010

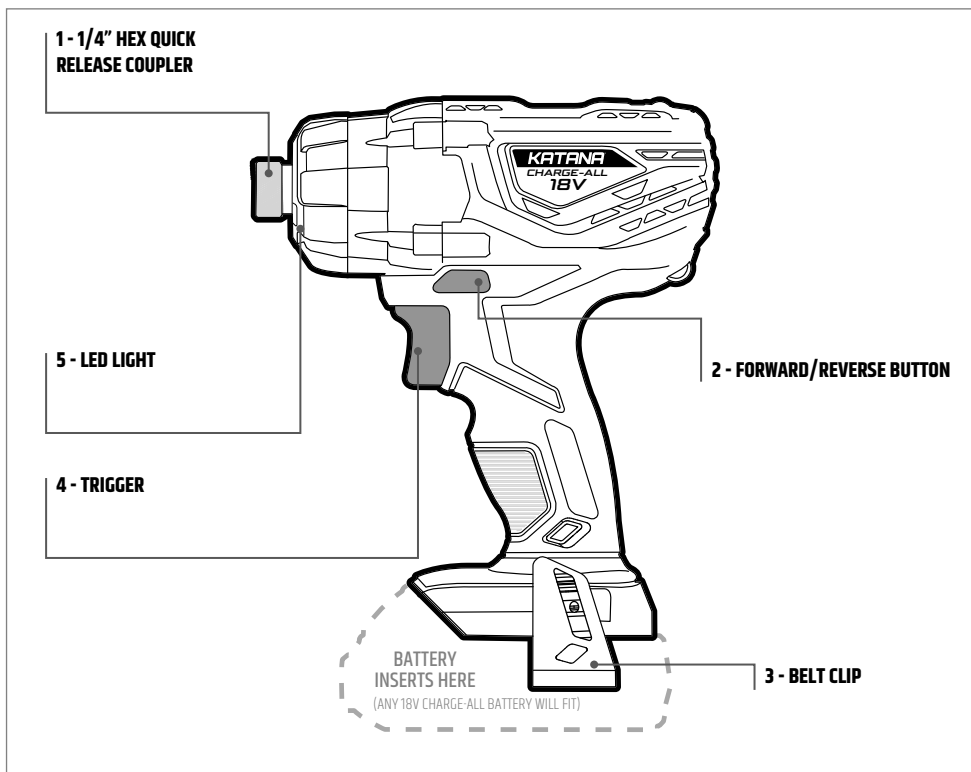

## SPECIFICATIONS

<b>Voltage</b>	18V d.c.	<b>Maximum torque</b>	116 ft-lb/158 Nm
<b>Coupler</b>	1/4" Hex	<b>No load speed</b>	0-3000 rpm
<b>Impact rate</b>	0-3000 ipm		

## HOW TO INSERT BATTERY ON TOOL

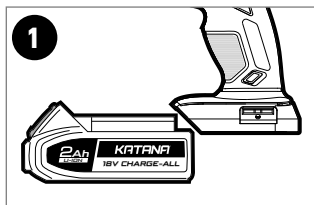

1. ALIGN BATTERY RIBS WITH TOOL

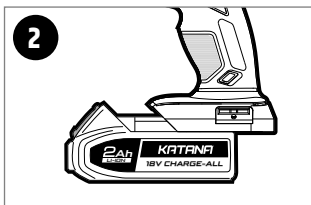

2. SLIDE INTO TOOL

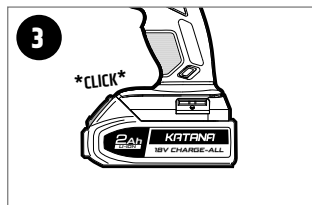

3. STOP WHEN YOU HEAR IT CLICK IN PLACE

**HOW TO INSERT A DRILL/DRIVER BIT**

220010

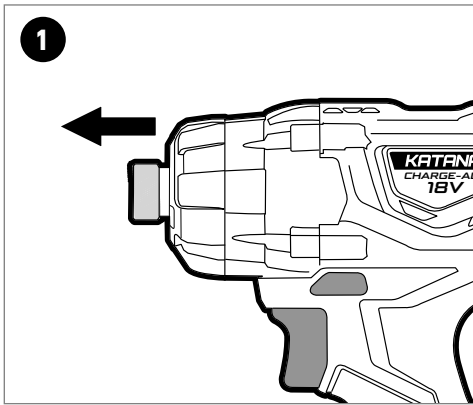

**1. PULL AND HOLD 1/4" HEX QUICK RELEASE COUPLER FORWARD (1)**

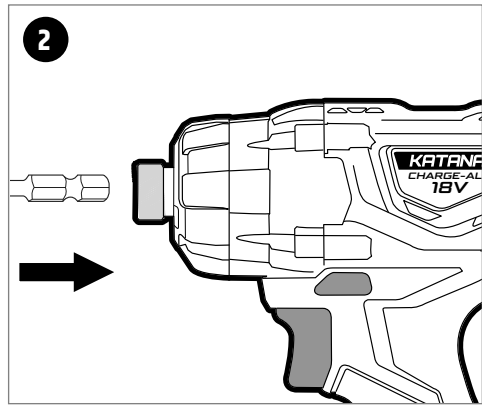

**2. INSERT ANY STANDARD 1/4" HEX DRILL OR DRIVER BIT**

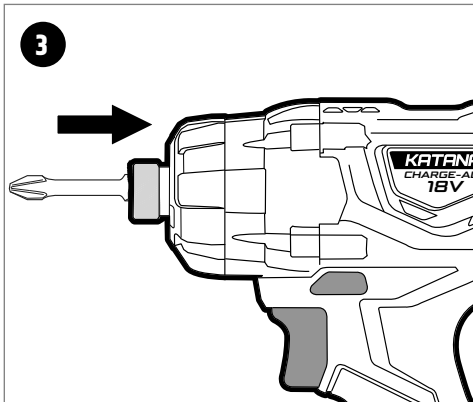

**3. RELEASE 1/4" HEX QUICK RELEASE COUPLER**

Ensure bit is inserted correctly and is secure

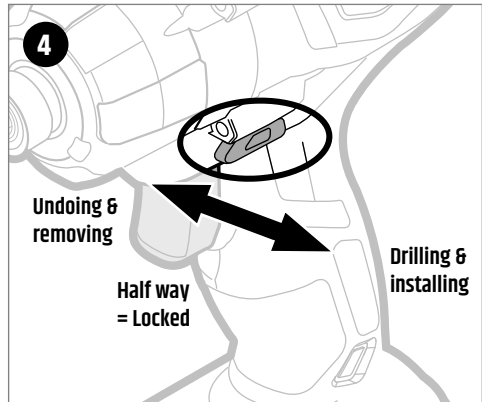

**4. SET IMPACT DRIVER DIRECTION FOR USE**

Set the forward/reverse button (2) to the desired direction:

Push in from the left - Undoing and removing.  
Push in from the right - Drilling and installing

**HOW TO USE THE IMPACT DRIVER**

**220010**



**1. ENSURE SAFETY**

Always wear safety glasses when working with the impact driver. Make sure to secure your hair and any baggy clothes. In appropriate situations make sure you wear ear muffs, a mask or a respiratory mask.

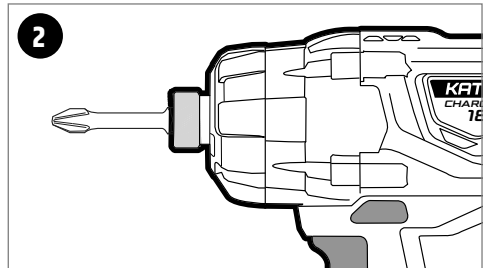

**2. MAKE SURE YOU HAVE THE CORRECT BIT**

Ensure you are using the correct bit for the job. See bit packaging for instructions. The impact driver will take all standard 1/4" hex shank driver bits.

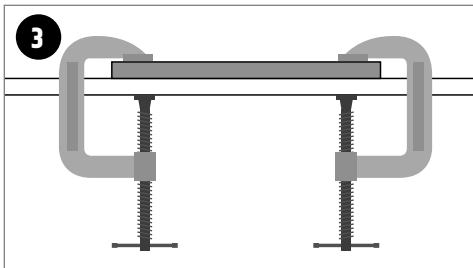

**3. SECURE WORKPIECE**

Make sure your workpiece is securely fastened to the surface to ensure no movement when drilling.

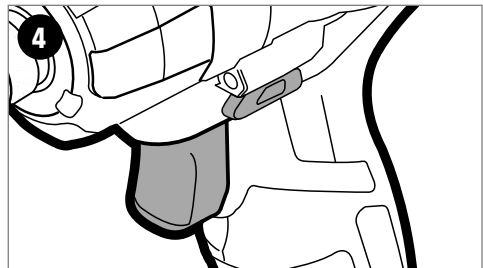

**4. ENSURE IMPACT DRIVER IS SET UP CORRECTLY**

Ensure the forward/reverse button (2) is in the correct position and the bit is securely inserted into the coupler.

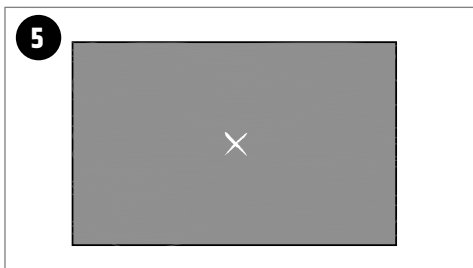

**5. MEASURE TWICE, CUT ONCE**

Have your job planned and marked out.

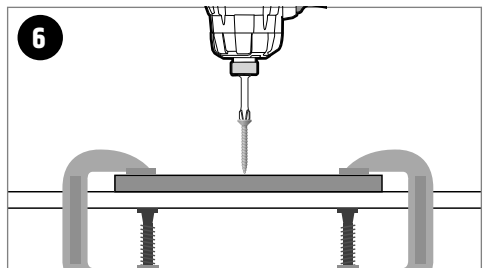

**6. DRILL YOUR WORKPIECE**

Hold the impact driver securely and press the trigger (4) whilst applying firm pressure directly down on the impact driver to stop the fastener from slipping. Slowly increase pressure on the trigger until the screw or bolt is tightened to desired depth.

## **MAINTENANCE**

---

**220010**

This power tool normally requires no maintenance; from time to time the ventilation slots on the motor casing should be cleaned out. If the unit should become defective, repair should be performed by an authorized service agent for electric tools.

Avoid using solvents when cleaning plastic parts. Most plastics are susceptible to damage from various types of commercial solvents and may be damaged by their use. Use clean cloths to remove dirt, dust, oil, grease, etc.

**Warning!**

*Do not at any time let brake fluids, gasoline, petroleum based products, penetrating oils, etc., come in contact with plastic parts. Chemicals can damage, weaken or destroy plastic which may result in serious personal injury.*

# KATANA®

## Australia & Global

[www.katanapowertools.com.au](http://www.katanapowertools.com.au)

[enquiries@katanapowertools.com.au](mailto:enquiries@katanapowertools.com.au)

+61 3 9730 7100

Made to Katana specifications and quality standards in China.

NOT INTENDED FOR TRADE USE

**5 YEAR WARRANTY\***

\* Standard 3 year warranty with an additional 2 year warranty available subject to online registration via [katanapowertools.com.au](http://katanapowertools.com.au). Warranty on this Katana product is given by Kinchrome Australia Pty Ltd of 3 Lakeview Drive, Caribbean Park, Scoresby, Victoria, Australia (Tel +61 3 9730 7100) If this product has materials or workmanship defects (other than defects caused by abnormal or non warranted use) you can, at your cost, send the product to place of purchase, an authorised Kinchrome service agent or one of Kinchromes addresses for repair or replacement.

Your rights under this warranty are in addition to any other rights you have under the Australian Consumer Law or other applicable laws. Our goods come with guarantees that cannot be excluded under the Australian Consumer Law. You are entitled to a replacement or refund for a major failure and compensation for any other reasonably foreseeable loss or damage. You are also entitled to have the goods repaired or replaced if the goods fail to be of acceptable quality and the failure does not amount to a major failure. For further details please visit [www.kinchrome.com.au](http://www.kinchrome.com.au) or call us. Due to minor changes in design or manufacture, the product you purchase may sometimes differ from the one shown on the packaging.